

- Table frame design features incorporate a nontip, nontrip & walk-through design.
- The one-piece welded construction frames are fabricated using continuous MIG welds for strength.
- All pipe and tubing conform to ASTM A513-94, and all steel components conform to ASTM-A569.
- All cross braces are 1" schedule 40 pipe (.133" thk. wall).
- Center brackets are all 1/8" thk. (12 ga.) steel. Table and seat brackets are 1/8" thk. (12 ga.) steel for P/N's 11137, 11138 and 11139, and 3/16" thk. (7 ga.) steel for P/N 11135.
- Assembly fasteners are 3/8" dia. galvanized steel carriage bolts.
- Optional lumber is predrilled and has 3/8" radius rounded corners.
- All exposed corners are chamfered for safety.
- Approximate weights of tables less lumber:
 P/N 11135 = 101 lbs
 P/N 11137 = 70 lbs
 P/N 11138 = 57 lbs
 P/N 11139 = 50 lbs

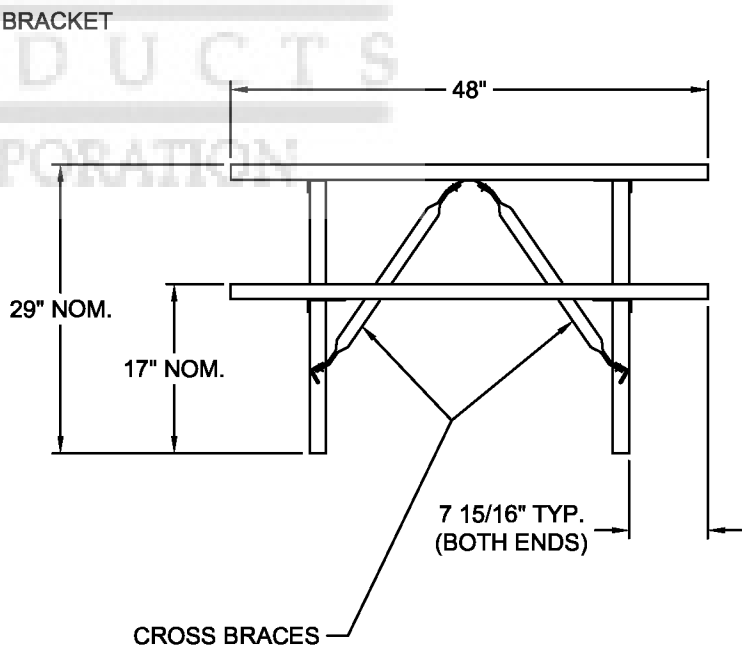

CUSTOMER APPROVAL :

DATE :

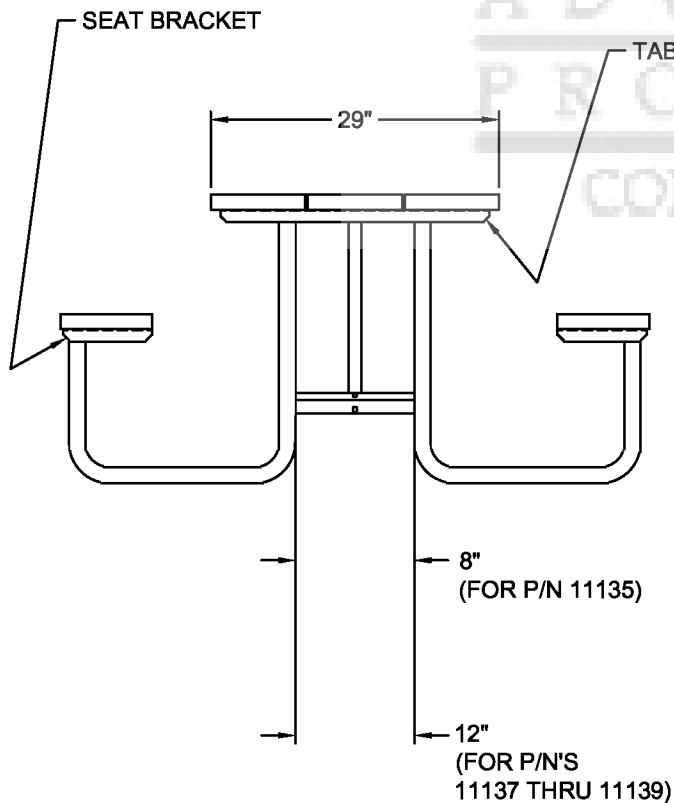

THIS DRAWING, WHICH CONTAINS PROPRIETARY INFORMATION, IS THE PROPERTY OF JAMESTOWN ADVANCED PRODUCTS CORPORATION. IT SHALL NOT BE REPRODUCED IN ANY MANNER NOR DISCLOSED TO THIRD PARTIES WITHOUT WRITTEN PERMISSION OF JAMESTOWN ADVANCED PRODUCTS CORPORATION.

DATE : 4-4-01

PRODUCT PART NUMBER : 11135, 37, 38 & 39 (-91 THRU -96)

REV. NO.

PRODUCT DESCRIPTION :
4' PICNIC TABLE

2855 GIRTS ROAD
JAMESTOWN, NY 14701